

Spherical roller bearings, cylindrical and tapered bore

Principal dimensions			Basic load ratings		Speed ratings		Designation
d	D	B	dynamic C	static C0	Reference speed	Limiting speed	
mm			kN		r/min		<b>* SKF Explorer bearing</b>
<b>95</b>	170	43	393	450	3600	4800	- 22219 EK *

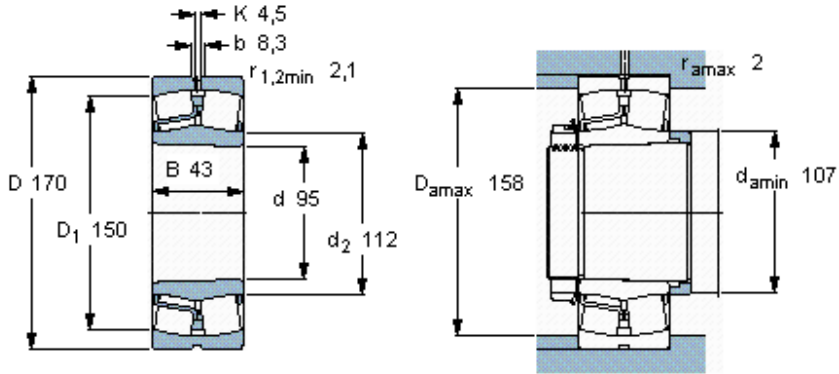

Tapered bore, taper  
1: 12

**Calculation factors**

- e 0,24
- $Y_1$  2,8
- $Y_2$  4,2
- $Y_0$  2,8